

Redwood

Lumber Patterns No. 17

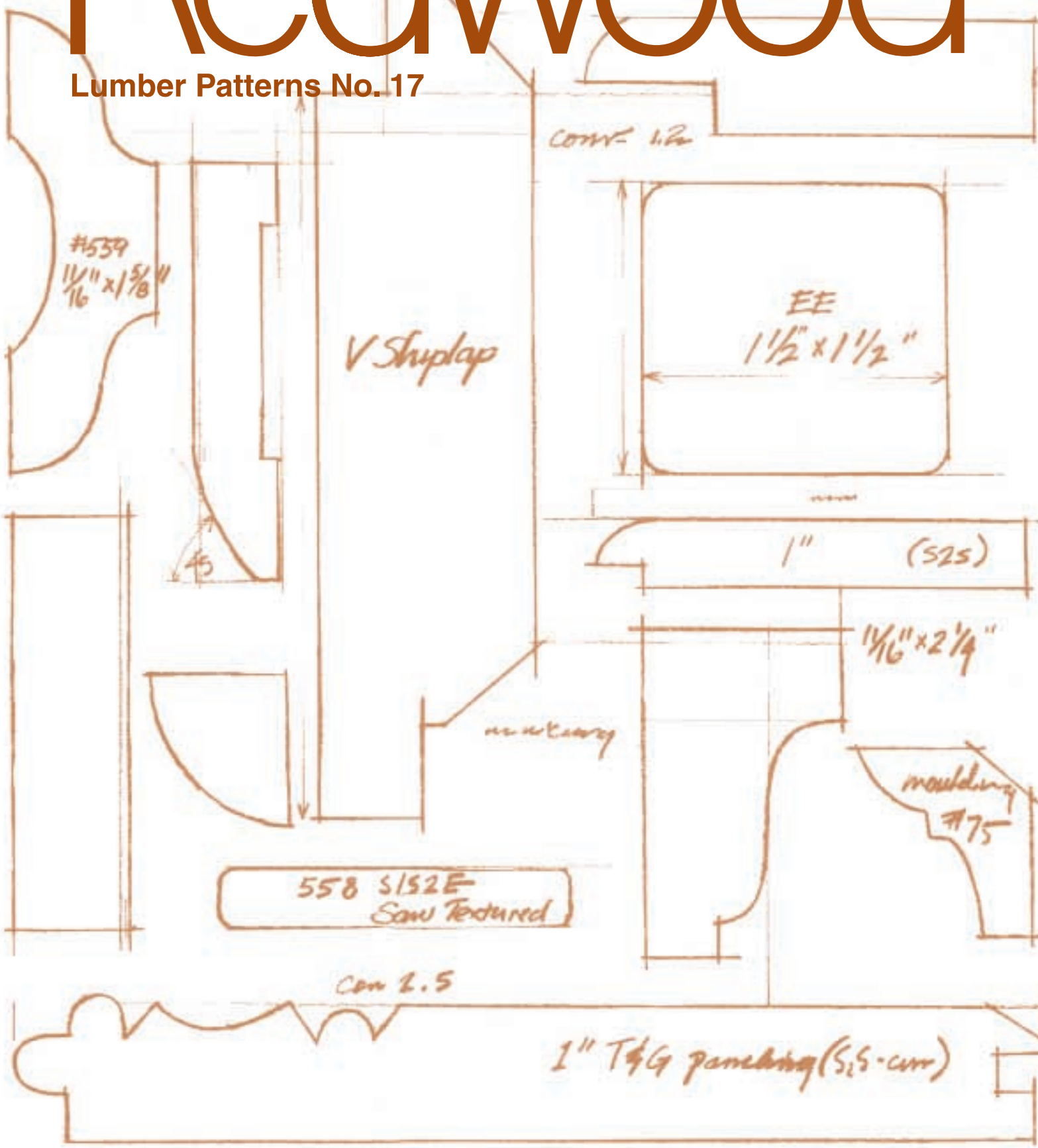

Redwood Lumber Patterns No. 17

3	REDWOOD GRADEMARKS
3	PATTERNS PROFILED IN THIS BOOK
3	SURFACE TEXTURE
3	GRAIN
3	CONVERSION FACTORS
3	FURTHER INFORMATION
4	S4S DRY DIMENSIONS
4	S4S GREEN DIMENSIONS
4	DESCRIPTION OF ABBREVIATIONS
5-9	TABLE OF CONTENTS

Redwood Patterns

10-12	TONGUE AND GROOVE
13	NAILING TONGUE & GROOVE PATTERNS
14-15	SHIPLAP
16	NAILING SHIPLAP PATTERNS
17-19	BEVEL
20	NAILING BEVEL PATTERNS
21	DECKING
22	PLOWED FASCIA
23	FENCING
24	MOULDING
25-26	INDEX



405 Enfrente Drive, Suite 200
Novato, California 94949-7201
Telephone 415 382-0662
Toll Free 888 Cal-Redwood
Fax 415 382-8531
www.calredwood.org

Redwood—our renewable resource

BRITT LUMBER

Britt Lumber Company, Inc.
P.O. Box 248
Arcata, California 95518-0248
Phone 707 822-1779
FAX 707 822-5645

mad river LUMBER

Redwood Fencing Experts
P.O. Box 1134
Arcata, CA 95518-1134
Phone 707 822-4384
FAX 707 822-2195



Mendocino Forest Products Company, LLC
420 Aviation Blvd. #103
Santa Rosa, CA 95403
Phone 707 576-8240
Fax 707 576-8259
www.mrc.com



P.O. Box 565
Scotia, California 95565-0565
Phone 707 764-8888
FAX 707 764-4444
www.palco.com



Schmidbauer Lumber Company
P.O. Box 152
Eureka, California 95502-0152
Phone 707 443-7024
FAX 707 443-2356



Simpson Timber Company
P.O. Box 1089
Arcata, California 95518-1089
Phone 800-637-7077
FAX 707 268-3089
www.simpsoncalifornia.com

Listed on this page are the member mills of the California Redwood Association. Individually, each member has earned a distinguished reputation for excellence in the production of redwood lumber products. Combined under the CRA hallmark, they continuously seek improvements in the processing and utilization of redwood. Thus, the CRA signature on redwood lumber assures that it has been manufactured to the highest quality standards.

REDWOOD GRADEMARKS

Redwood grades and patterns are established by the Redwood Inspection Service which is the official redwood grading agency accredited by the American Lumber Standard Committee, Inc., Board of Review. Grade rules are published in the *Standard Specifications for Grades of California Redwood Lumber*.

Properly grademarked lumber will bear the RIS mark or that of another accredited inspection bureau. The CRA trademark is on products of the member mills of the California Redwood Association only and is an additional assurance of quality.

Standard grademarks include the grade designation and the symbol of an authorized grading agency. They shall also identify the manufacturer and the moisture content at the time of manufacture. Grademarks may appear on the face, edge or end of a piece.



Lumber that has been kiln dried according to accepted standards includes the words "Certified Kiln Dried" or the initials "CKD" in the grademark.

In some cases, an RIS Certificate of Inspection may be used to identify the lumber grade. Certificates of Inspection include all the pertinent information described above as well as the name of the producer and the inspector.

PATTERNS PROFILED IN THIS BOOK

Illustrated on the following pages are the pattern profiles of worked redwood lumber produced by the members of the California Redwood Association. These profiles and dimensions have been established to simplify the specifying and ordering of pattern lumber.

All patterns shown are pictured as they are usually run through the matcher as viewed from the head of the machine looking toward the outfeed end.

SURFACE TEXTURE

Pattern lumber—lumber shaped to a pattern or moulded form—is supplied surfaced (smooth planed) or saw-textured. Many products are produced surfaced one side and saw-textured one side. This surface is derived from resawing at the planer mill and is not to be confused with the surface of rough lumber (the initial product manufactured at the headrig in a sawmill).

Saw-textured surfaces are preferable for many applications because they hold finishes better and show blemishes less.

GRAIN

Redwood sidings are sold as vertical grain (VG), flat grain (FG) or mixed grain (MG). The annual growth rings in vertical grain lumber form an angle of 45 degrees or more with the surface of the piece. All lumber not meeting this requirement is known as flat grain.

Vertical grain lumber has superior performance qualities in the areas of dimensional stability and finish-holding characteristics.

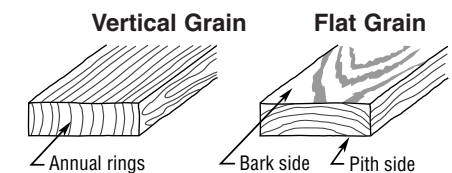

CONVERSION FACTORS

Conversion factors for siding, paneling, decking and fencing patterns are based on surface measure and must be doubled to calculate board measure for 2-inch lumber patterns. To estimate surface measure, multiply the area to be covered (in square feet) by the conversion factor. This factor allows for width lost in dressing or lapping. Add three to five percent for end cutting and matching on the job.

FURTHER INFORMATION

The California Redwood Association publishes a wide variety of publications relating to redwood products. Contact the Association for product, technical and promotional information or go to www.calredwood.org to view and download literature that is of interest to you.

Grade rules for redwood:
Standard Specifications for Grades of California Redwood Lumber

Specifying redwood:
Redwood Grades & Uses
Redwood Architectural Guide
Redwood Landscape Architecture

Applying redwood:
Redwood CKD Siding Patterns and Applications
Redwood Deck Construction

Finishing redwood:
Redwood Exterior Finishes
Redwood Interior Finishes
Painting Redwood Siding: Guidelines to Extending Maintenance Cycles

REDWOOD TONGUE AND GROOVE PATTERNS

S4S DRY DIMENSIONS (INCHES)

Nominal	Dressed ¹	Nominal	Dressed	Nominal	Dressed
1x2	1 ¹ / ₁₆ x 1 ¹ / ₂ *	1 ¹ / ₄ x2	1x1 ¹ / ₂ *	2x2	1 ¹ / ₂ x1 ¹ / ₂ *
1x3	1 ¹ / ₁₆ x2 ¹ / ₂ **	1 ¹ / ₄ x3	1x2 ¹ / ₂ **	2x3	1 ¹ / ₂ x2 ¹ / ₂ **
1x4	1 ¹ / ₁₆ x3 ¹ / ₂	1 ¹ / ₄ x4	1x3 ¹ / ₂	2x4	1 ¹ / ₂ x3 ¹ / ₂
1x6	1 ¹ / ₁₆ x5 ¹ / ₂	1 ¹ / ₄ x6	1x5 ¹ / ₂	2x6	1 ¹ / ₂ x5 ¹ / ₂
1x8	1 ¹ / ₁₆ x7 ¹ / ₄	1 ¹ / ₄ x8	1x7 ¹ / ₄	2x8	1 ¹ / ₂ x7 ¹ / ₄
1x10	1 ¹ / ₁₆ x9 ¹ / ₄	1 ¹ / ₄ x10	1x9 ¹ / ₄	2x10	1 ¹ / ₂ x9 ¹ / ₄
1x12	1 ¹ / ₁₆ x11 ¹ / ₄	1 ¹ / ₄ x12	1x11 ¹ / ₄	2x12	1 ¹ / ₂ x11 ¹ / ₄

MOST SIZES AVAILABLE S1S2E SAW-TEXTURED ONE SIDE²

*Also available surfaced at 1⁵/₁₆ inch net.
**Also available surfaced at 2⁵/₁₆ inch net.

S4S GREEN DIMENSIONS (INCHES)

Nominal	Dressed ¹	Nominal	Dressed	Nominal	Dressed
1x2	2 ⁵ / ₃₂ x1 ⁹ / ₁₆	1 ¹ / ₄ x2	1 ¹ / ₃₂ x1 ⁹ / ₁₆	2x2	1 ⁹ / ₁₆ x1 ⁹ / ₁₆
1x3	2 ⁵ / ₃₂ x2 ⁹ / ₁₆	1 ¹ / ₄ x3	1 ¹ / ₃₂ x2 ⁹ / ₁₆	2x3	1 ⁹ / ₁₆ x2 ⁹ / ₁₆
1x4	2 ⁵ / ₃₂ x3 ⁹ / ₁₆	1 ¹ / ₄ x4	1 ¹ / ₃₂ x3 ⁹ / ₁₆	2x4	1 ⁹ / ₁₆ x3 ⁹ / ₁₆
1x6	2 ⁵ / ₃₂ x5 ⁹ / ₁₆	1 ¹ / ₄ x6	1 ¹ / ₃₂ x5 ⁹ / ₁₆	2x6	1 ⁹ / ₁₆ x5 ⁹ / ₁₆
1x8	2 ⁵ / ₃₂ x7 ³ / ₈	1 ¹ / ₄ x8	1 ¹ / ₃₂ x7 ³ / ₈	2x8	1 ⁹ / ₁₆ x7 ³ / ₈
1x10	2 ⁵ / ₃₂ x9 ³ / ₈	1 ¹ / ₄ x10	1 ¹ / ₃₂ x9 ³ / ₈	2x10	1 ⁹ / ₁₆ x9 ³ / ₈
1x12	2 ⁵ / ₃₂ x11 ³ / ₈	1 ¹ / ₄ x12	1 ¹ / ₃₂ x11 ³ / ₈	2x12	1 ⁹ / ₁₆ x11 ³ / ₈

MOST SIZES AVAILABLE S1S2E SAW-TEXTURED ONE SIDE²

¹ Boards less than the minimum thickness for nominal 1 inch but 5/8 inch or greater thickness dry (11/16 inch green) shall be regarded as American Softwood Lumber Standard (ALS) lumber, but such boards shall be marked to show the size and condition of seasoning at the time of dressing. They shall also be distinguished from nominal 1-inch boards on invoices and certificates.

² Variation resulting from resawing surfaced redwood lumber may be plus or minus 1/32 inch.

DESCRIPTION OF ABBREVIATIONS

T&G = TONGUE & GROOVE.

S1S = SURFACED ONE SIDE.

S1S2E = SURFACED ONE SIDE TWO EDGES.

S2S = SURFACED TWO SIDES.

S4S = SURFACED FOUR SIDES.

EE = EASED EDGE (ROUNDED).

CM = CENTER MATCHED (TONGUE & GROOVE ARE EQUAL DISTANCE FROM BOTH SIDES).

V1S = VEE EDGES—ONE SIDE.

V2S = VEE EDGES—BOTH SIDES.

V&CV = VEE EDGES—AND CENTER VEE.

R = REVERSIBLE PATTERN (S1S-Saw-Textured 1S).

SAW-TEXTURED (SEE SURFACE TEXTURE—PAGE 3).

NOTE: LUMBER LESS THAN 2 INCHES THICK IS NORMALLY ROUNDED AS NEAR AS POSSIBLE TO A 1/16-INCH RADIUS, 2-INCH LUMBER TO A 1/8-INCH RADIUS. S4S LUMBER MAY BE RUN EASED EDGE OR SQUARE EDGE AT MILL OPTION UNLESS OTHERWISE SPECIFIED.

PATTERN NUMBER	DESCRIPTION	PAGE	PATTERN NUMBER	DESCRIPTION	PAGE
16	1x6 T&G Paneling (S2S-CM)	10	711	1x6 T&G (V1S-S2S) 1/4"V	12
17	1x8 T&G Paneling (S2S-CM)	10	711R	1x6 T&G (V2S-S1S-Saw-textured 1S) 1/4"V	12
18	1x10 T&G Paneling (S2S-CM)	10	712	1x8 T&G (V1S-S2S) 1/4"V	12
204	5/8 x 4 T&G (V1S-S2S) 3/32"V	10	712R	1x8 T&G (V2S-S1S-Saw-textured 1S) 1/4"V	12
205	5/8 x 6 T&G (V1S-S2S) 3/32"V	10	713	1x10 T&G (V1S-S2S) 1/4"V	12
206	5/8 x 8 T&G (V1S-S2S) 3/32"V	10	713R	1x10 T&G (V2S-S1S-Saw-textured 1S) 1/4"V	12
606	1x6 T&G Drop Siding (S2S)	10	715	1x8 T&G (V1S-S2S) 3/32"V	11
616	1x6 T&G V&CV (S2S) 1/4"V	10	715R	1x8 T&G (V2S-S1S-Saw-textured 1S) 3/32"V	11
617	1x8 T&G V&CV (S2S) 1/4"V	10	716	1x10 T&G (V1S-S2S) 3/32"V	11
632	1x4 T&G (S2S-CM)	11	716R	1x10 T&G (V2S-S1S-Saw-textured 1S) 3/32"V	11
632EE	1x4 T&G EE (S2S-CM)	11	726R	1x6 T&G (V2S-S1S-Saw-textured 1S) 1/8"V	12
633	1x6 T&G (S2S-CM)	11	727R	1x8 T&G (V2S-S1S-Saw-textured 1S) 1/8"V	12
633EE	1x6 T&G EE (S2S-CM)	11	728R	1x10 T&G (V2S-S1S-Saw-textured 1S) 1/8"V	12
634	1x8 T&G (S2S-CM)	11	732R	1x4 T&G (V2S-S1S-Saw-textured 1S) 1/4"V	12
634EE	1x8 T&G EE (S2S-CM)	11	733R	1x6 T&G (V2S-S1S-Saw-textured 1S) 1/4"V	12
707	1x4 T&G (V1S-S2S) 3/32"V	11	734R	1x8 T&G (V2S-S1S-Saw-textured 1S) 1/4"V	12
707R	1x4 T&G (V2S-S1S-Saw-textured 1S) 3/32"V	11			
708	1x6 T&G (V1S-S2S) 3/32"V	11			
708R	1x6 T&G (V2S-S1S-Saw-textured 1S) 3/32"V	11			
709	1x4 T&G (V1S-S2S) 1/4"V	12			
709R	1x4 T&G (V2S-S1S-Saw-textured 1S) 1/4"V	12			

REDWOOD SHIPLAP PATTERNS

PATTERN NUMBER	DESCRIPTION	PAGE	PATTERN NUMBER	DESCRIPTION	PAGE
761	1x6 Shiplap (S2S)	14	785R	1x8 Channel V&CV Shiplap (S1S-Saw-textured 1S) 1/4"V	15
762	1x8 Shiplap (S2S)	14	786R	1x10 Channel V&CV Shiplap (S1S-Saw-textured 1S) 1/4"V	15
763	1x10 Shiplap (S2S)	14	793	1x6 V Shiplap (S2S) 1/4"V	15
770	1x6 Cove Shiplap (S2S)	14	793R	1x6 V Shiplap (V2S-S1S-Saw-textured 1S) 1/4"V	15
771	1x8 Cove Shiplap (S2S)	14	794	1x8 V Shiplap (S2S) 1/4"V	15
772	1x10 Cove Shiplap (S2S)	14	794R	1x8 V Shiplap (V2S-S1S-Saw-textured 1S) 1/4"V	15
773	1x10 Channel Shiplap (S2S) Beveled Channel	14	795	1x10 V Shiplap (S2S) 1/4"V	15
774	1x6 Channel Shiplap (S2S) Square Channel	14	795R	1x10 V Shiplap (V2S-S1S-Saw-textured 1S) 1/4"V	15
775	1x8 Channel Shiplap (S2S) Square Channel	14	810	1x6 Boston Shiplap (S2S)	15
776	1x10 Channel Shiplap (S2S) Square Channel	14	811	1x8 Boston Shiplap (S2S)	15
784R	1x6 Channel V&CV Shiplap (S1S-Saw-textured 1S) 1/4"V	15	812	1x10 Boston Shiplap (S2S)	15

REDWOOD BEVEL PATTERNS

PATTERN NUMBER	DESCRIPTION	PAGE	PATTERN NUMBER	DESCRIPTION	PAGE
320R	1/2x4 Plain Saw-textured Bevel Siding (S1S2E)	17	391	3/4x6 Rabbeted Saw-textured Bevel Siding (S1S2E)	18
321R	1/2x5 Plain Saw-textured Bevel Siding (S1S2E)	17	392	3/4x8 Rabbeted Saw-textured Bevel Siding (S1S2E)	18
322R	1/2x6 Plain Saw-textured Bevel Siding (S1S2E)	17	393	3/4x10 Rabbeted Saw-textured Bevel Siding (S1S2E)	18
323R	1/2x8 Plain Saw-textured Bevel Siding (S1S2E)	17	400	1/2x4 Rabbeted Bevel Siding Round Edge (S1S2E)	18
329R	3/4x6 Plain Saw-textured Bevel Siding (S1S2E)	17	422	1 1/4x6 Plain Saw-textured Bevel Siding (S1S2E)	18
330R	3/4x8 Plain Saw-textured Bevel Siding (S1S2E)	17	423	1 1/4x8 Plain Saw-textured Bevel Siding (S1S2E)	18
331R	3/4x10 Plain Saw-textured Bevel Siding (S1S2E)	17	424	1 1/4x10 Plain Saw-textured Bevel Siding (S1S2E)	18
360	1/2x4 Rabbeted Bevel Siding (S1S2E)	17	430	1x6 2 LAP (Round Edge) Drop Siding (S1S2E)	19
362	1/2x6 Rabbeted Bevel Siding (S1S2E)	17	431	1x8 2 LAP (Round Edge) Drop Siding (S1S2E)	19
363	1/2x8 Rabbeted Bevel Siding (S1S2E)	17	433	1x10 3 LAP (Round Edge) Drop Siding (S1S2E)	19
371	3/4x6 Rabbeted Bevel Siding (S1S2E)	17	476	1 1/4x6 Rabbeted Saw-textured Bevel Siding (S1S2E)	19
372	3/4x8 Rabbeted Bevel Siding (S1S2E)	17	477	1 1/4x8 Rabbeted Saw-textured Bevel Siding (S1S2E)	19
373	3/4x10 Rabbeted Bevel Siding (S1S2E)	17			

REDWOOD DECKING PATTERNS

PATTERN NUMBER	DESCRIPTION	PAGE	PATTERN NUMBER	DESCRIPTION	PAGE
482 2x6	T&G Decking (S2S-CM)	21	487 2x8	T&G Decking (V1S-S2S) ¼"V	21
484 2x8	T&G Decking (S2S-CM)	21	488 2x10	T&G Decking (V1S-S2S) ¼"V	21
486 2x6	T&G Decking (V1S-S2S) ¼"V	21	489 2x12	T&G Decking (V1S-S2S) ¼"V	21

REDWOOD FENCING PATTERNS

PATTERN NUMBER	DESCRIPTION	PAGE	PATTERN NUMBER	DESCRIPTION	PAGE
28 1x6	Fencing (S2S)	23	30 1x6	Fencing (S2S)	23
29 1x8	Fencing (S2S)	23	31 1x8	Fencing (S2S)	23

REDWOOD PLOWED FASCIA PATTERNS

PATTERN NUMBER	DESCRIPTION	PAGE	PATTERN NUMBER	DESCRIPTION	PAGE
80 1x6	Single Plow EE	22	85 1x8	Single Plow EE	22
81 1x8	Single Plow EE	22	88 1x6	Double Plow EE	22
84 1x6	Single Plow EE	22	89 1x8	Double Plow EE	22

REDWOOD MOULDING PATTERNS

PATTERN NUMBER	DESCRIPTION	PAGE	PATTERN NUMBER	DESCRIPTION	PAGE
75 1½x1½	Bed Mould	24	266 5/16x1½	Lattice	24
105 1½x1½	Quarter Round Mould	24	267 5/16x1½	Lattice	24
175 1½x2	Brick Mould	24	268 5/16x1½	Lattice	24
176 1½x1½	Brick Mould	24	558 5/16x2½	Flat Batten	24
180 1½x2	Brick Mould	24	559 1½x1½	O.G. Batten	24
208 1½x2¼	Panel Mould	24	560 1½x2¼	O.G. Batten	24
210 1½x1½	Panel Mould	24	712 9/16x3½	Base Mould	24
236EE 1½x1½	Panel Mould	24	862 1½x2½	Garage Door Stop	24
			863 1½x2¼	Garage Door Stop	24

REDWOOD TONGUE & GROOVE PATTERNS

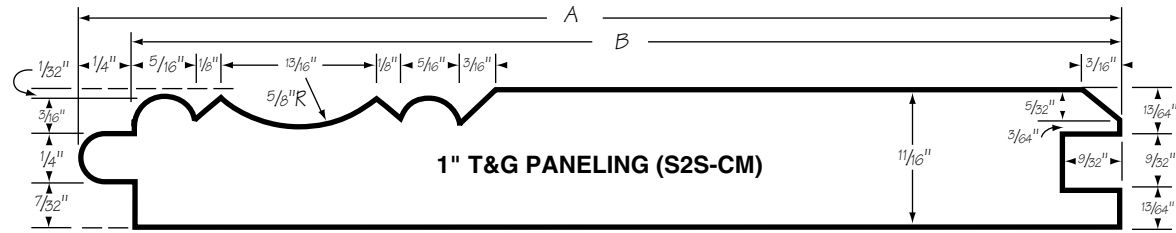

NOMINAL SIZE	PATTERN NUMBER	A	B	CONVERSION FACTOR
1x6	16	5 ³ / ₈	5 ¹ / ₈	1.18
1x8	17	7 ¹ / ₈	6 ⁷ / ₈	1.17
1x10	18	9 ¹ / ₈	8 ⁷ / ₈	1.13

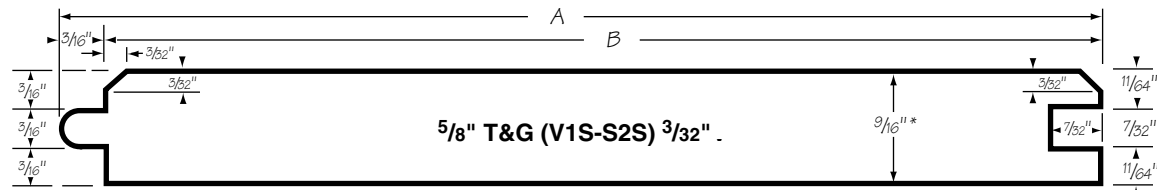

NOMINAL SIZE	PATTERN NUMBER	A	B	CONVERSION FACTOR
5/8x4	204	3 ³ / ₈	3 ³ / ₁₆	1.26
5/8x6	205	5 ³ / ₈	5 ³ / ₁₆	1.16
5/8x8	206	7 ¹ / ₈	6 ¹⁵ / ₁₆	1.16

*Also available surfaced at 7/16 inch.

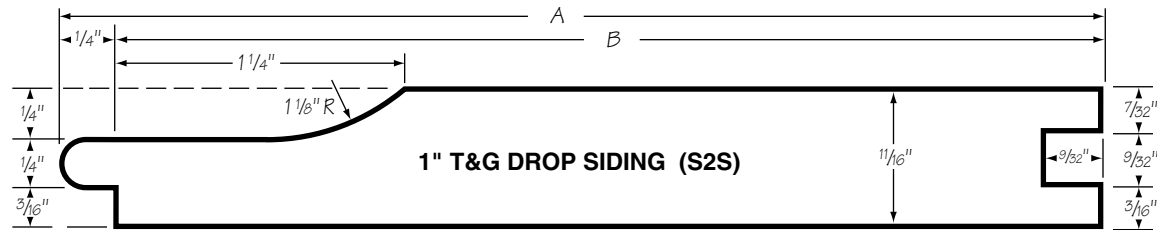

NOMINAL SIZE	PATTERN NUMBER	A	B	CONVERSION FACTOR
1x6	606	5 ³ / ₈	5 ¹ / ₈	1.17

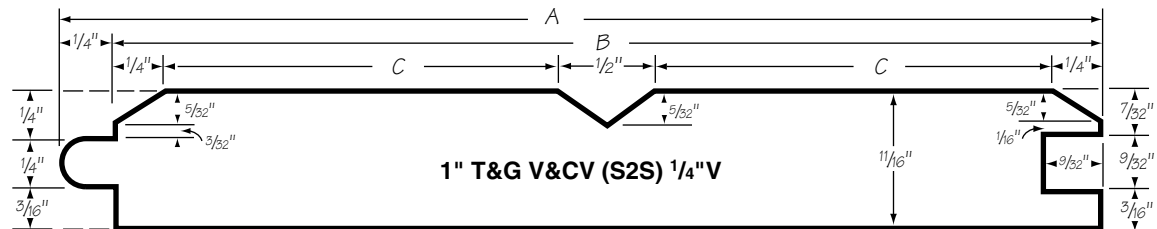

NOMINAL SIZE	PATTERN NUMBER	A	B	C	CONVERSION FACTOR
1x6	616	5 ³ / ₈	5 ¹ / ₈	2 ¹ / ₁₆	1.17
1x8	617	7 ¹ / ₈	6 ⁷ / ₈	2 ¹⁵ / ₁₆	1.16

REDWOOD TONGUE & GROOVE PATTERNS

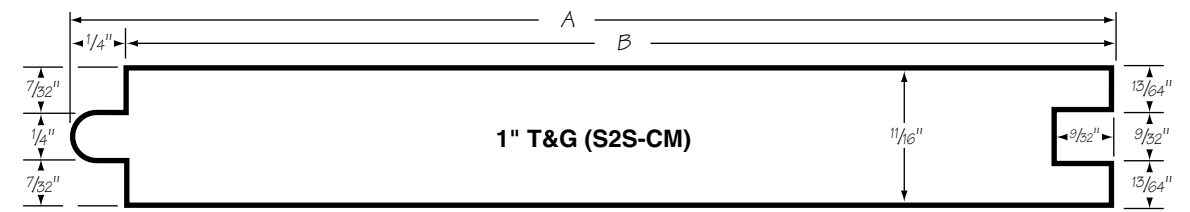

NOMINAL SIZE	PATTERN NUMBER	A	B	CONVERSION FACTOR
1x4	632	3 ³ / ₈	3 ¹ / ₈	1.28
1x6	633	5 ³ / ₈	5 ¹ / ₈	1.18
1x8	634	7 ¹ / ₈	6 ⁷ / ₈	1.17

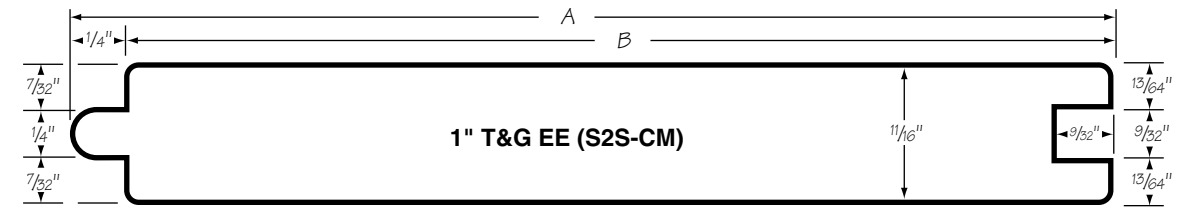

NOMINAL SIZE	PATTERN NUMBER	A	B	CONVERSION FACTOR
1x4	632EE	3 ³ / ₈	3 ¹ / ₈	1.28
1x6	633EE	5 ³ / ₈	5 ¹ / ₈	1.18
1x8	634EE	7 ¹ / ₈	6 ⁷ / ₈	1.17

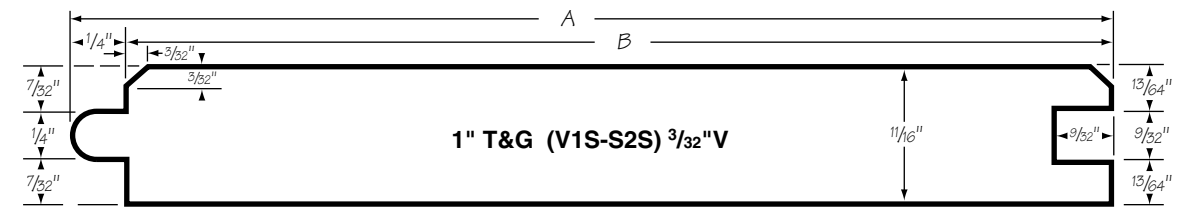

NOMINAL SIZE	PATTERN NUMBER	A	B	CONVERSION FACTOR
1x4	707	3 ³ / ₈	3 ¹ / ₈	1.28
1x6	708	5 ³ / ₈	5 ¹ / ₈	1.18
1x8	715	7 ¹ / ₈	6 ⁷ / ₈	1.17
1x10	716	9 ¹ / ₈	8 ⁷ / ₈	1.13

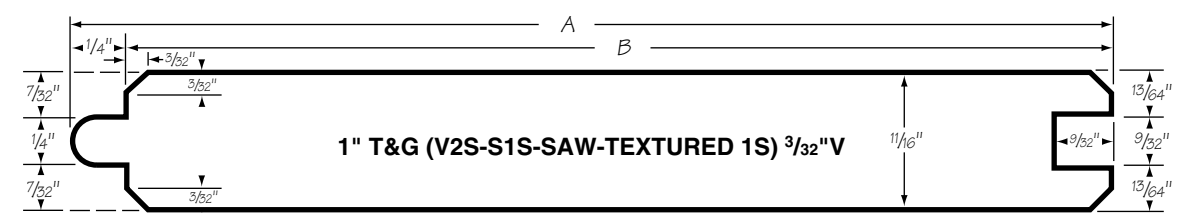

NOMINAL SIZE	PATTERN NUMBER	A	B	CONVERSION FACTOR
1x4	707R	3 ³ / ₈	3 ¹ / ₈	1.28
1x6	708R	5 ³ / ₈	5 ¹ / ₈	1.18
1x8	715R	7 ¹ / ₈	6 ⁷ / ₈	1.17
1x10	716R	9 ¹ / ₈	8 ⁷ / ₈	1.13

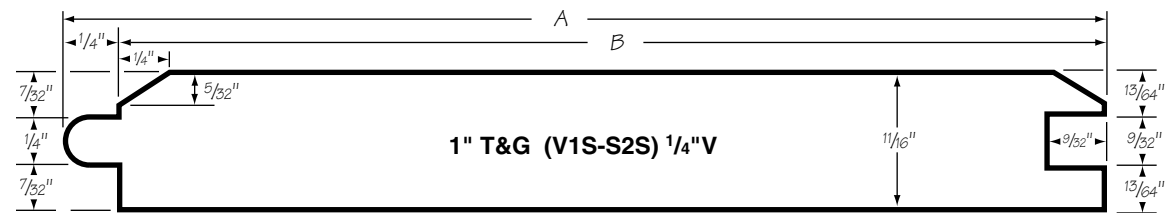

NOMINAL SIZE	PATTERN NUMBER	A	B	CONVERSION FACTOR
1x4	709	3 ³ / ₈	3 ¹ / ₈	1.28
1x6	711	5 ³ / ₈	5 ¹ / ₈	1.18
1x8	712	7 ¹ / ₈	6 ⁷ / ₈	1.17
1x10	713	9 ¹ / ₈	8 ⁷ / ₈	1.13

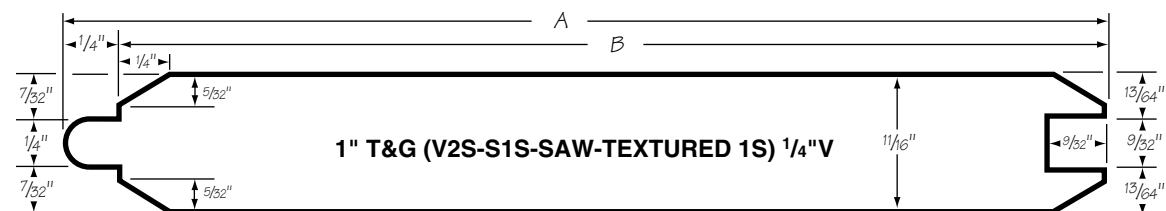

NOMINAL SIZE	PATTERN NUMBER	A	B	CONVERSION FACTOR
1x4	709R	3 ³ / ₈	3 ¹ / ₈	1.28
1x6	711R	5 ³ / ₈	5 ¹ / ₈	1.18
1x8	712R	7 ¹ / ₈	6 ⁷ / ₈	1.17
1x10	713R	9 ¹ / ₈	8 ⁷ / ₈	1.13

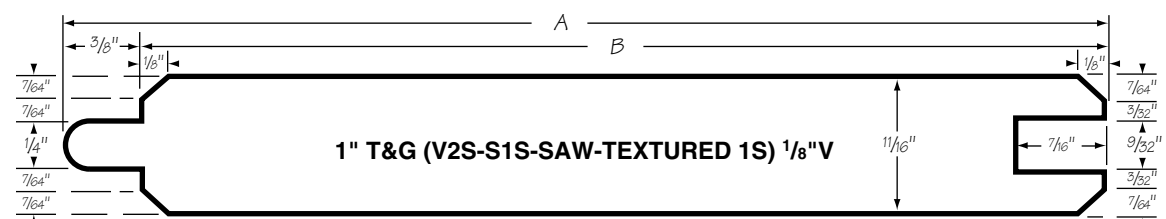

NOMINAL SIZE	PATTERN NUMBER	A	B	CONVERSION FACTOR
1x6	726R	5 ³ / ₈	5*	1.20
1x8	727R	7 ¹ / ₈	6 ³ / ₄ *	1.19
1x10	728R	9 ¹ / ₈	8 ³ / ₄ *	1.15

*Under ALS size

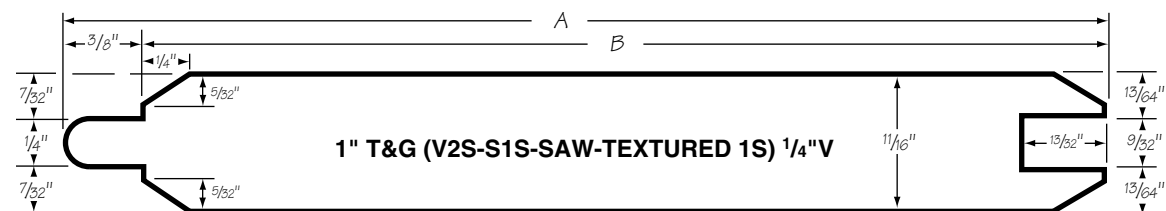

NOMINAL SIZE	PATTERN NUMBER	A	B	CONVERSION FACTOR
1x4	732R	3 ³ / ₈	3*	1.33
1x6	733R	5 ³ / ₈	5*	1.20
1x8	734R	7 ¹ / ₈	6 ³ / ₄ *	1.19

*Under ALS size

TONGUE & GROOVE NAILING METHOD Horizontal or Vertical Siding (Sideview)

Blind nail 4- and 6-inch widths through the tongue with finish nails. Use one nail per bearing.

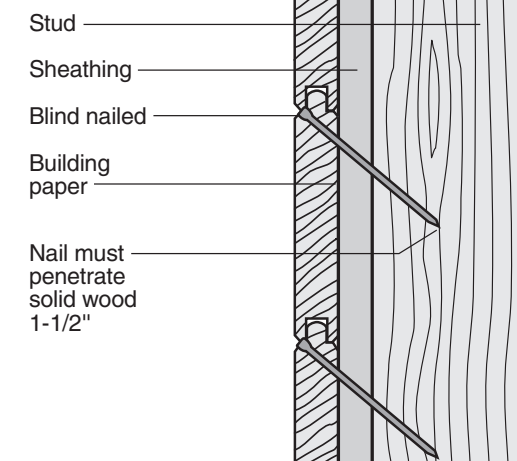

For patterns wider than six inches, face nail using two 8-penny nails per bearing. Position nails one-quarter of the width of the material in from each edge

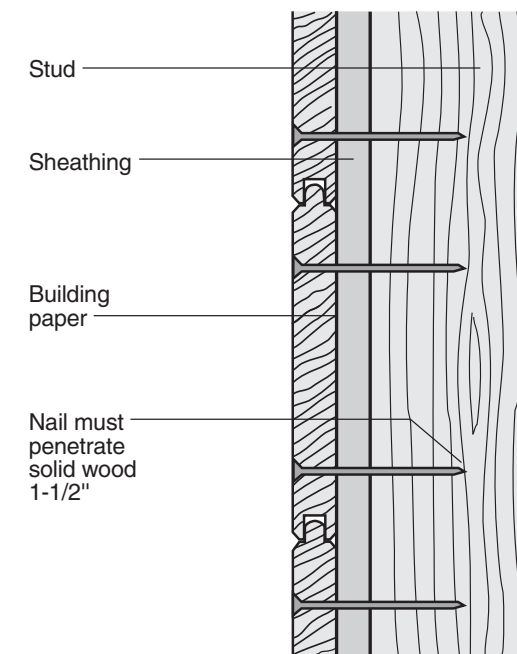

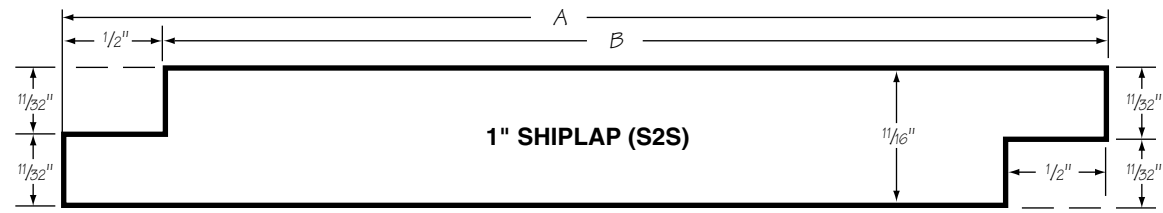

NOMINAL SIZE	PATTERN NUMBER	A	B	CONVERSION FACTOR
1x6	761	5 ³ / ₈	4 ⁷ / ₈	1.24
1x8	762	7 ¹ / ₈	6 ⁵ / ₈	1.21
1x10	763	9 ¹ / ₈	8 ⁵ / ₈	1.16

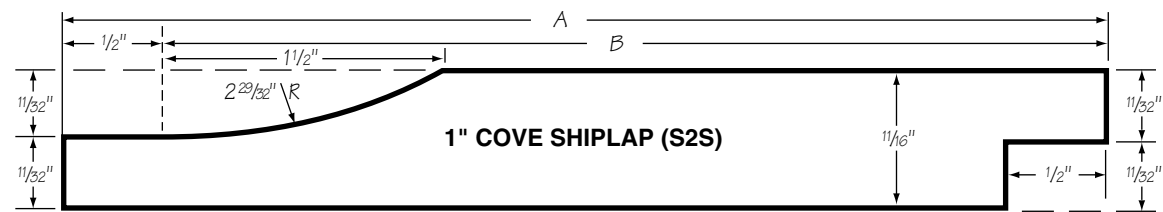

NOMINAL SIZE	PATTERN NUMBER	A	B	CONVERSION FACTOR
1x6	770	5 ³ / ₈	4 ⁷ / ₈	1.24
1x8	771	7 ¹ / ₈	6 ⁵ / ₈	1.21
1x10	772	9 ¹ / ₈	8 ⁵ / ₈	1.16

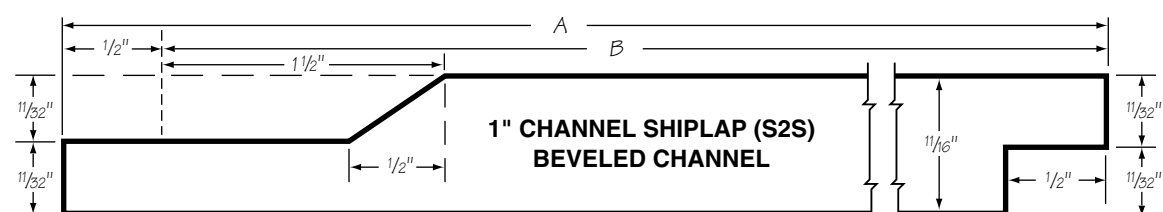

NOMINAL SIZE	PATTERN NUMBER	A	B	CONVERSION FACTOR
1x10	773	9 ¹ / ₈	8 ⁵ / ₈	1.16

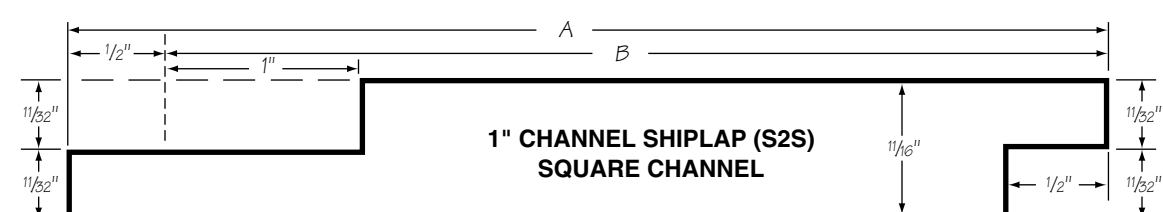

NOMINAL SIZE	PATTERN NUMBER	A	B	CONVERSION FACTOR
1x6	774	5 ³ / ₈	4 ⁷ / ₈	1.24
1x8	775	7 ¹ / ₈	6 ⁵ / ₈	1.21
1x10	776	9 ¹ / ₈	8 ⁵ / ₈	1.16

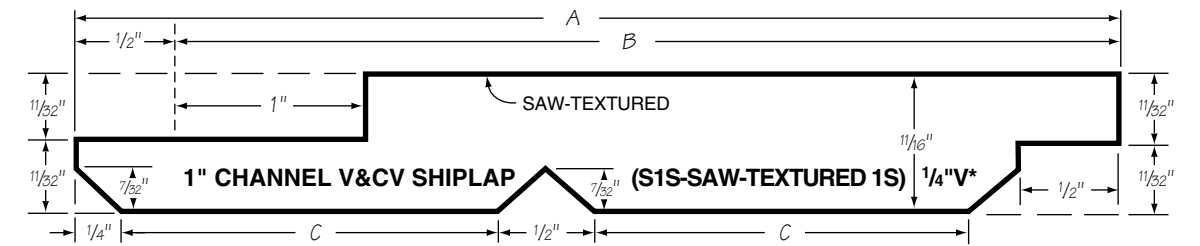

NOMINAL SIZE	PATTERN NUMBER	A	B	C	CONVERSION FACTOR
1x6	784R	5 ³ / ₈	4 ⁷ / ₈	1 ¹⁵ / ₁₆	1.24
1x8	785R	7 ¹ / ₈	6 ⁵ / ₈	2 ¹³ / ₁₆	1.21
1x10	786R	9 ¹ / ₈	8 ⁵ / ₈	3 ¹³ / ₁₆	1.16

*Also available without 1/2" Center V

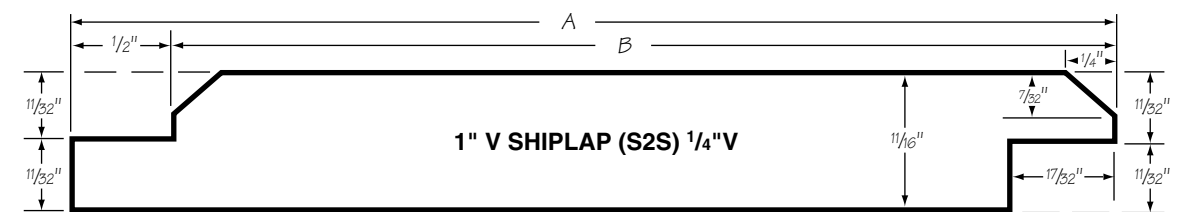

NOMINAL SIZE	PATTERN NUMBER	A	B	CONVERSION FACTOR
1x6	793	5 ³ / ₈	4 ⁷ / ₈	1.24
1x8	794	7 ¹ / ₈	6 ⁵ / ₈	1.21
1x10	795	9 ¹ / ₈	8 ⁵ / ₈	1.16

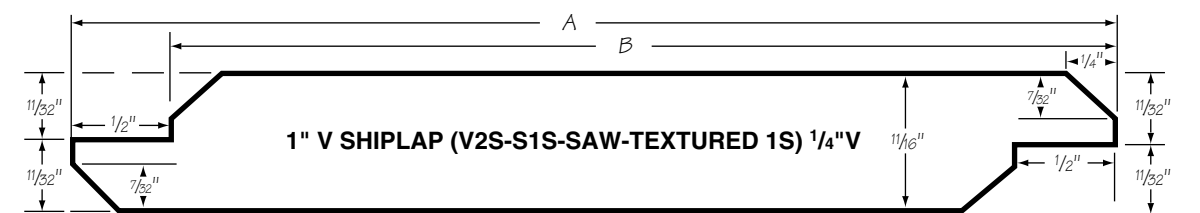

NOMINAL SIZE	PATTERN NUMBER	A	B	CONVERSION FACTOR
1x6	793R	5 ³ / ₈	4 ⁷ / ₈	1.24
1x8	794R	7 ¹ / ₈	6 ⁵ / ₈	1.21
1x10	795R	9 ¹ / ₈	8 ⁵ / ₈	1.16

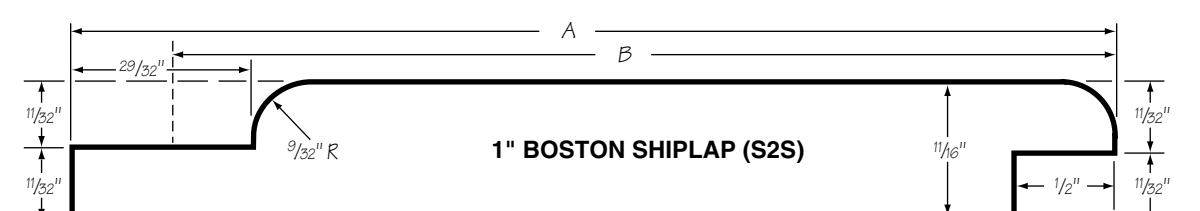

NOMINAL SIZE	PATTERN NUMBER	A	B	CONVERSION FACTOR
1x6	810	5 ³ / ₈	4 ⁷ / ₈	1.24
1x8	811	7 ¹ / ₈	6 ⁵ / ₈	1.21
1x10	812	9 ¹ / ₈	8 ⁵ / ₈	1.16

V SHIPLAP NAILING METHOD Horizontal or Vertical Siding (Side view)

For all V Shiplap patterns, face nail with two siding nails per bearing.

For 6-inch wide V-Shiplap, the nail location should be one inch from the overlapping edges.

For wider patterns, position nails one quarter the width of the material in from each edge.

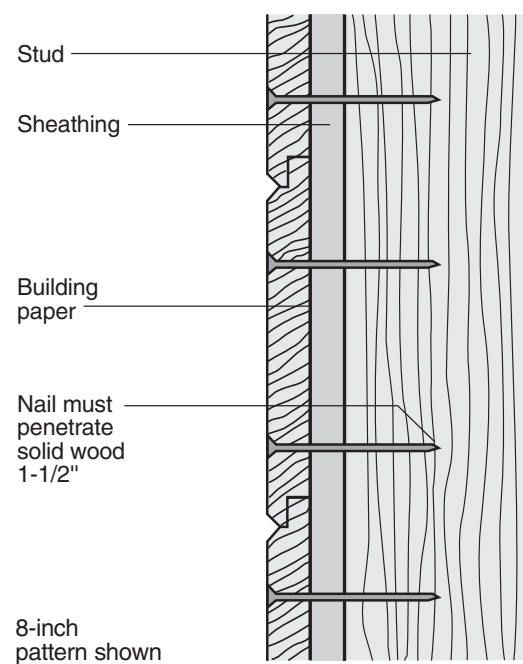

CHANNEL SHIPLAP* NAILING METHOD Vertical Siding (Overhead view)

Face nail with two nails per bearing for all patterns.

Space nails 1 inch from edge of overlap and 1-1/2 inches from edge of underlap for 6-inch patterns. For 8-inch boards, space nails 1-1/2 inches from edge of overlap and 2 inches from edge of underlap.

Nail wider patterns proportionately.

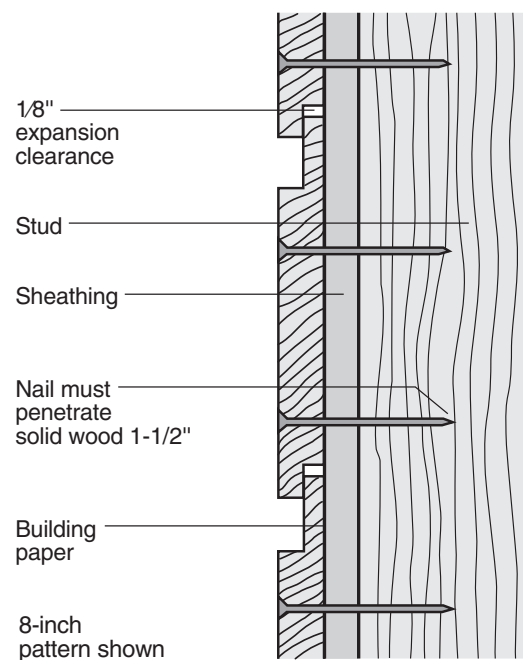

*NOTE: Allow 1/8" expansion gap at the edges of courses for CKD Channel Shiplap patterns. With air-seasoned Channel Shiplap patterns, butt the edges snugly together.

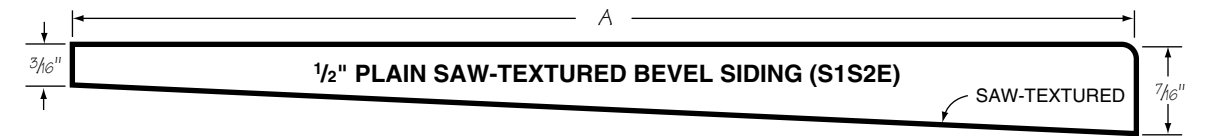

NOMINAL SIZE	PATTERN NUMBER	A	CONVERSION FACTOR
1/2 x 4	320R	3 1/2	1.60
1/2 x 5	321R	4 1/2	1.43
1/2 x 6	322R	5 1/2	1.34
1/2 x 8	323R	7 1/4	1.28

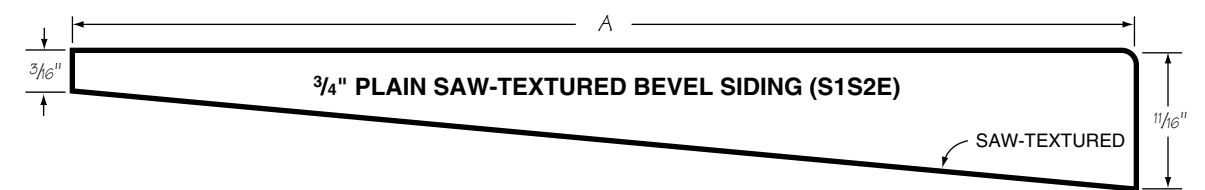

NOMINAL SIZE	PATTERN NUMBER	A	CONVERSION FACTOR
3/4 x 6	329R	5 1/2	1.34
3/4 x 8	330R	7 1/4	1.28
3/4 x 10	331R	9 1/4	1.22



NOMINAL SIZE	PATTERN NUMBER	A	CONVERSION FACTOR
1/2 x 4	360	3 1/2	1.28
1/2 x 6	362	5 1/2	1.17
1/2 x 8	363	7 1/4	1.17

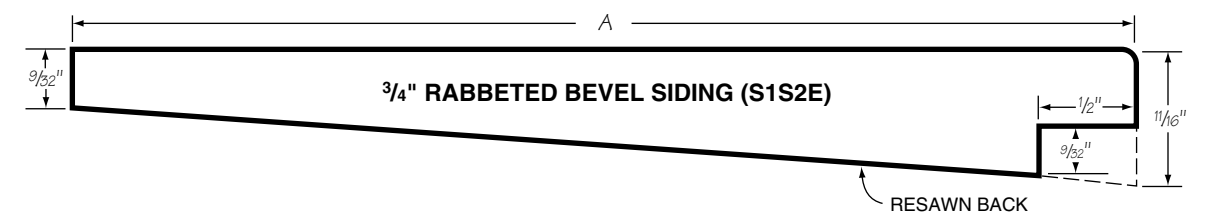

NOMINAL SIZE	PATTERN NUMBER	A	CONVERSION FACTOR
3/4 x 6	371	5 1/2	1.17
3/4 x 8	372	7 1/4	1.17
3/4 x 10	373	9 1/4	1.13

REDWOOD BEVEL PATTERNS

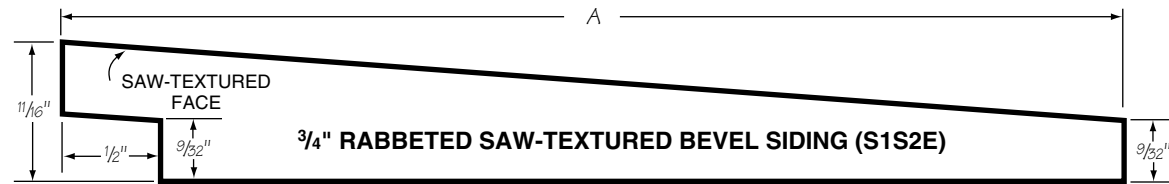

NOMINAL SIZE	PATTERN NUMBER	A	CONVERSION FACTOR
3/4 x 6	391	5 1/2	1.17
3/4 x 8	392	7 1/4	1.17
3/4 x 10	393	9 1/4	1.13

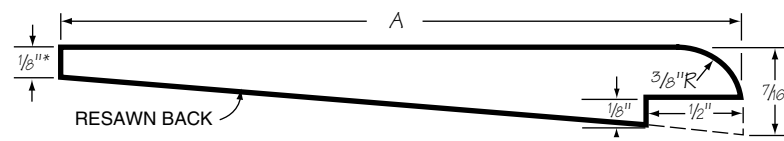

1/2" RABBETED BEVEL SIDING ROUND EDGE (S1S2E)

NOMINAL SIZE	PATTERN NUMBER	A	CONVERSION FACTOR
1/2 x 4	400	3 1/2	1.28

*Under ALS size

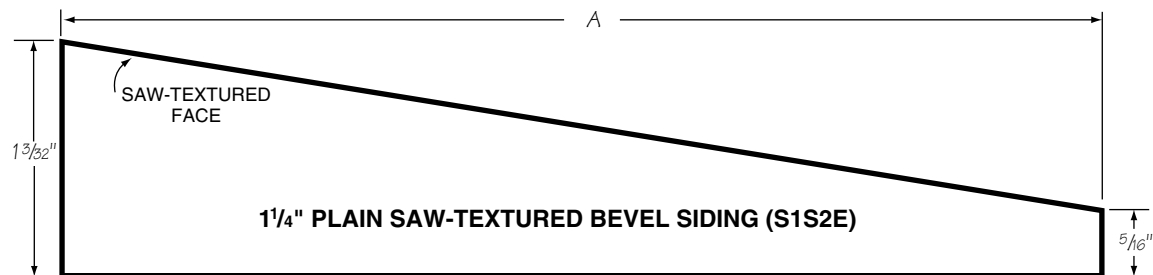

1/4" PLAIN SAW-TEXTURED BEVEL SIDING (S1S2E)

NOMINAL SIZE	PATTERN NUMBER	A	CONVERSION FACTOR
1 1/4 x 6	422	5 3/8*	1.37
1 1/4 x 8	423	7 1/8*	1.31
1 1/4 x 10	424	9 1/8*	1.23

*Under ALS size

REDWOOD BEVEL PATTERNS

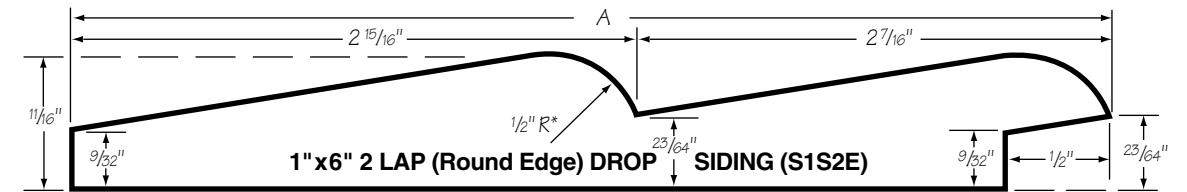

NOMINAL SIZE	PATTERN NUMBER	A	CONVERSION FACTOR
1 x 6	430	5 3/8	1.20

*This pattern is also available with 3/8" radius

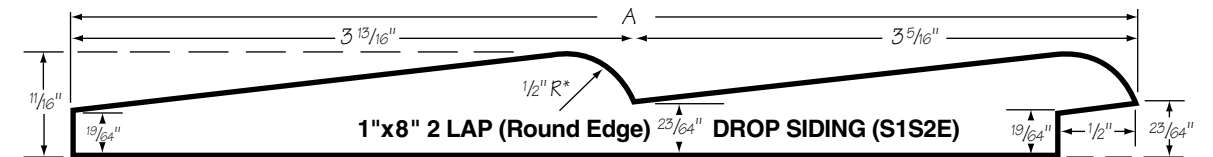

1" x 8" 2 LAP (Round Edge) DROP SIDING (S1S2E)

Illustration is smaller than actual size.

NOMINAL SIZE	PATTERN NUMBER	A	CONVERSION FACTOR
1 x 8	431	7 1/8	1.19

*This pattern is also available with 3/8" radius

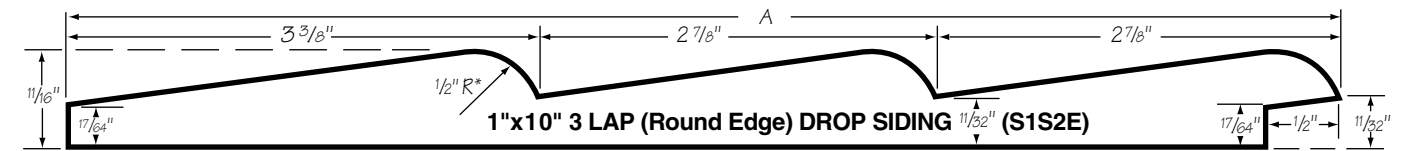

1" x 10" 3 LAP (Round Edge) DROP SIDING (S1S2E)

Illustration is smaller than actual size.

NOMINAL SIZE	PATTERN NUMBER	A	CONVERSION FACTOR
1 x 10	433	9 1/8	1.15

*This pattern is also available with 3/8" radius

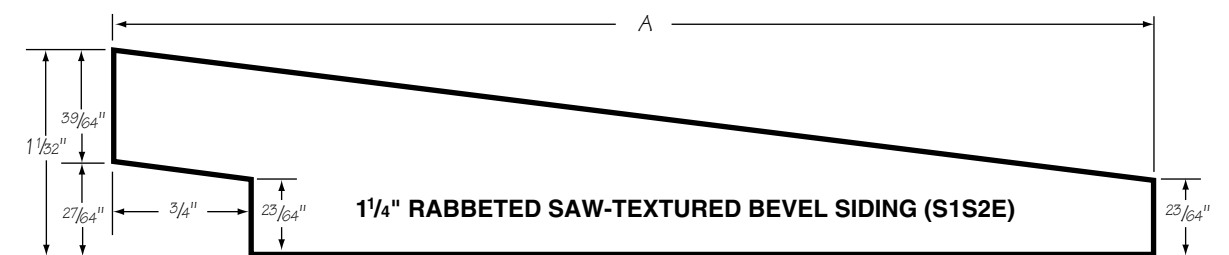

1/4" RABBETED SAW-TEXTURED BEVEL SIDING (S1S2E)

NOMINAL SIZE	PATTERN NUMBER	A	CONVERSION FACTOR
1 1/4 x 6	476	5 3/8*	1.30
1 1/4 x 8	477	7 1/8*	1.25

*Under ALS size

**PLAIN BEVEL
NAILING METHOD**
Horizontal Siding
(Side view)

Face nail with one nail only per bearing. Drive nail so shank clears the top of the preceding undercourse.

BEWARE OF DRIVING NAIL HOME WITH TOO HEAVY A FINAL BLOW. WOOD MAY SPLIT OR CUP DUE TO NON-SUPPORT IN CAVITY.

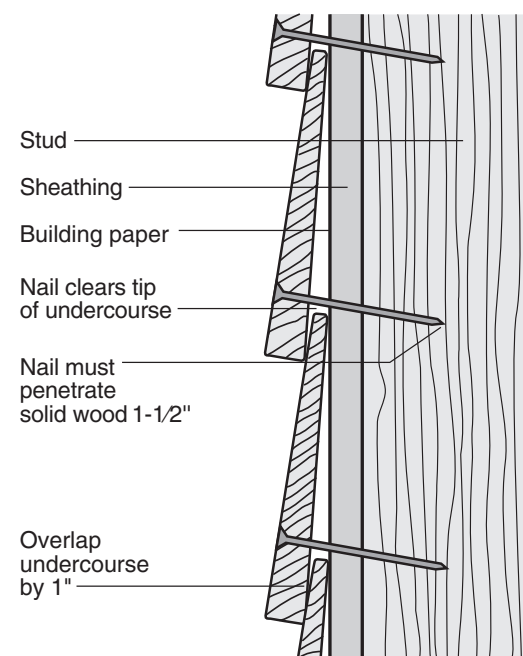

RABBETED BEVEL*
NAILING METHOD
Horizontal Siding
(Side view)

Face nail with one nail only per bearing. Drive nail about one inch above lower edge of course.

*NOTE: Allow 1/8" expansion gap at rabbet for CKD Rabbeted Bevel patterns. With air-seasoned Rabbeted Bevel patterns, butt the edges snugly together.

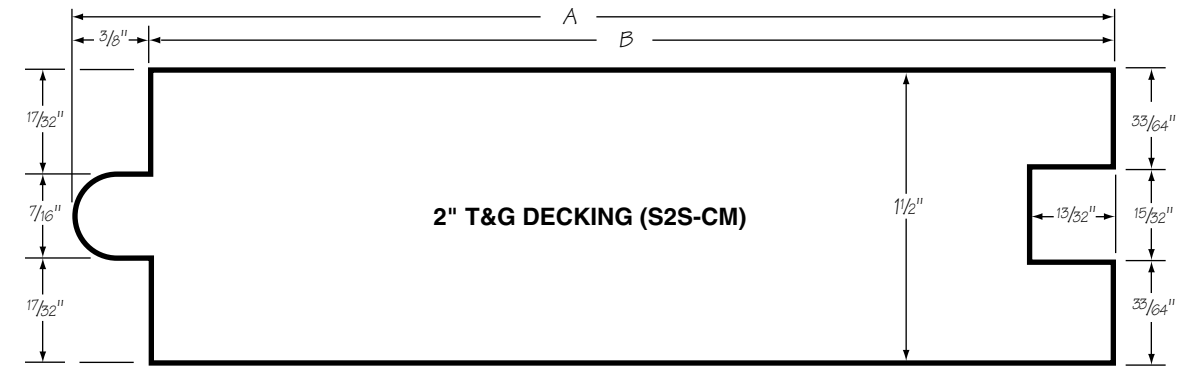
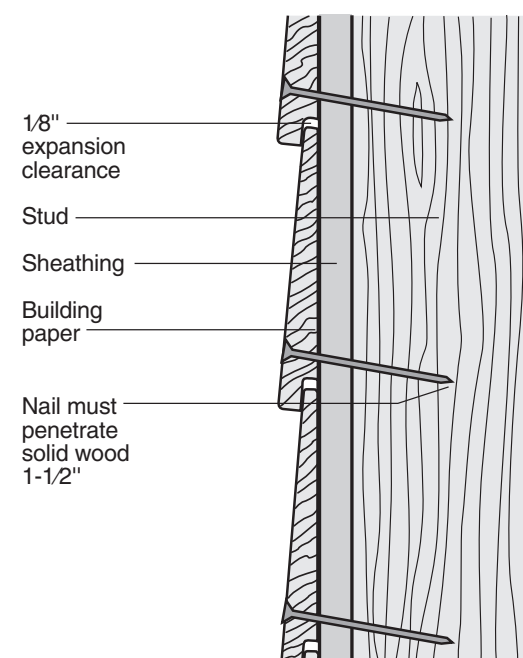

NOMINAL SIZE	PATTERN NUMBER	A	B	CONVERSION FACTOR
2x6	482	5 3/8"	5"	1.20
2x8	484	7 1/8"	6 3/4"	1.19

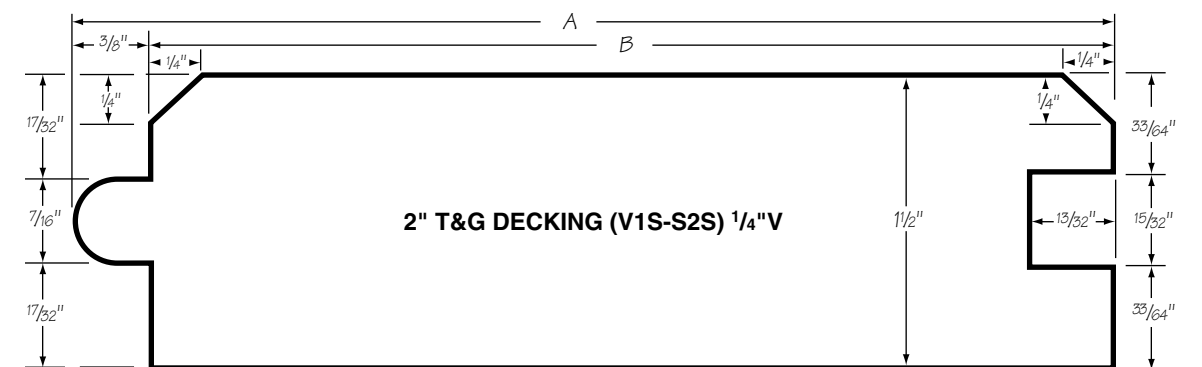

NOMINAL SIZE	PATTERN NUMBER	A	B	CONVERSION FACTOR
2x6	486	5 3/8"	5"	1.20
2x8	487	7 1/8"	6 3/4"	1.19
2x10	488	9 1/8"	8 3/4"	1.15
2x12	489	11 1/8"	10 3/4"	1.12

REDWOOD PLOWED FASCIA PATTERNS

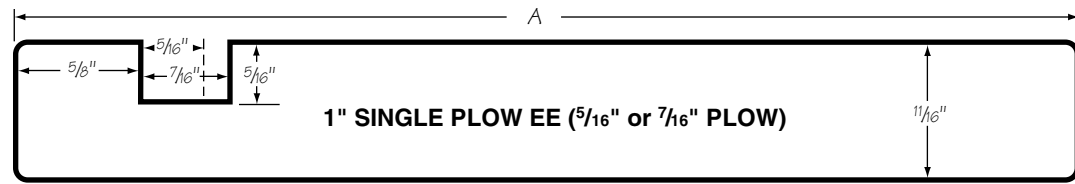

NOMINAL SIZE	PATTERN NUMBER	PLOW	A
1x6	80	$\frac{5}{16}$	$5\frac{1}{2}$
1x8	81	$\frac{5}{16}$	$7\frac{1}{4}$
1x6	84	$\frac{7}{16}$	$5\frac{1}{2}$
1x8	85	$\frac{7}{16}$	$7\frac{1}{4}$

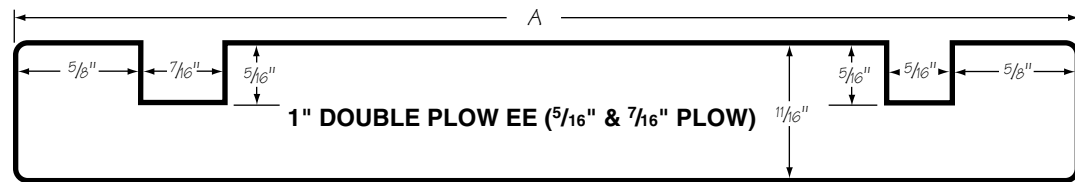

NOMINAL SIZE	PATTERN NUMBER	A
1x6	88	$5\frac{1}{2}$
1x8	89	$7\frac{1}{4}$

REDWOOD FENCING PATTERNS

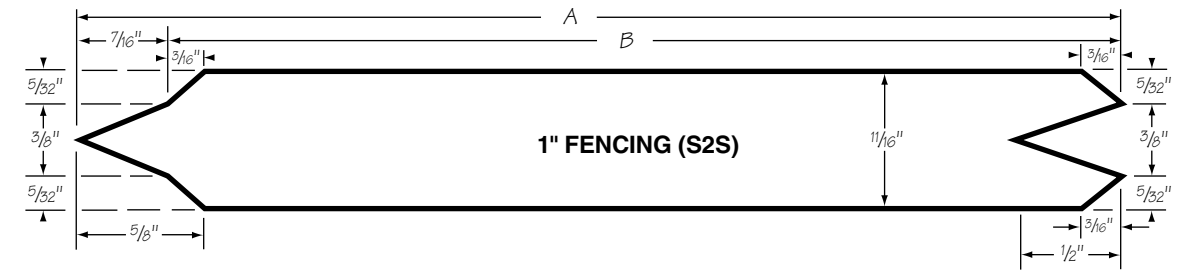

NOMINAL SIZE	PATTERN NUMBER	A	B	CONVERSION FACTOR
1x6	28	$5\frac{3}{8}$	$4\frac{15}{16}$	1.22
1x8	29	$7\frac{1}{8}$	$6\frac{11}{16}$	1.20

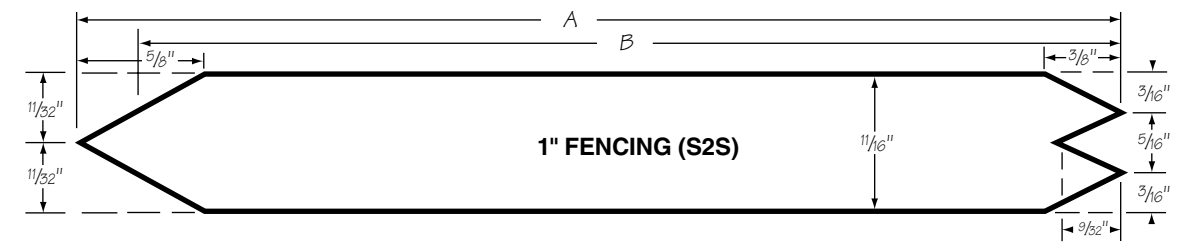

NOMINAL SIZE	PATTERN NUMBER	A	B	CONVERSION FACTOR
1x6	30	$5\frac{3}{8}$	$5\frac{3}{32}$	1.18
1x8	31	$7\frac{1}{8}$	$6\frac{27}{32}$	1.17



SIDING AND PANELING PATTERNS

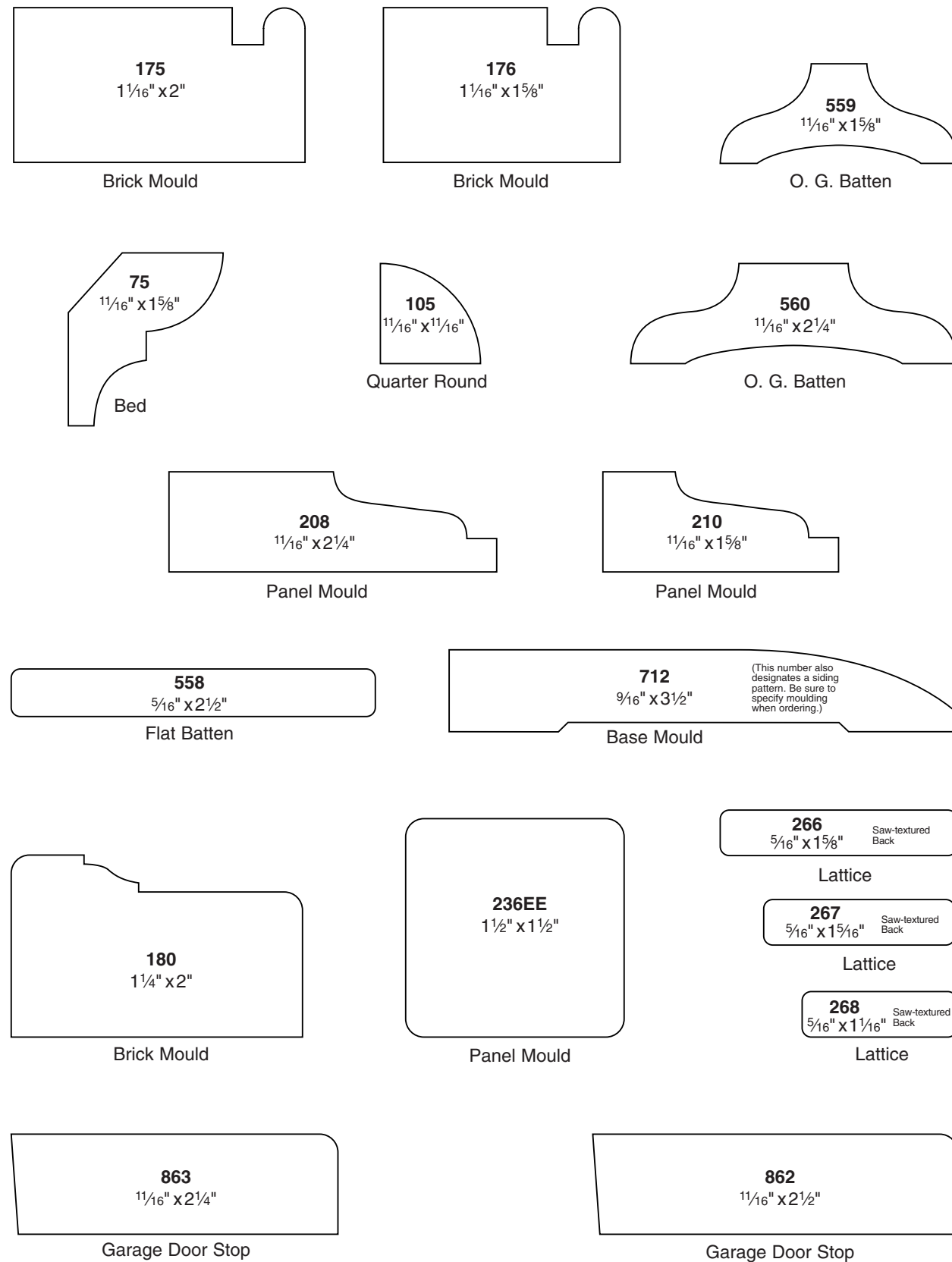

PATTERN NUMBER		DESCRIPTION	PAGE	PATTERN NUMBER	DESCRIPTION	PAGE
16	1x6	T&G Paneling (S2S-CM)	10	707	1x4 T&G (V1S-S2S) 3/32"V	11
17	1x8	T&G Paneling (S2S-CM)	10	707R	1x4 T&G (V2S-S1S-Saw-textured 1S) 3/32"V	11
18	1x10	T&G Paneling (S2S-CM)	10	708	1x6 T&G (V1S-S2S) 3/32"V	11
204	5/8x4	T&G (V1S-S2S) 3/32"V	10	708R	1x6 T&G (V2S-S1S-Saw-textured 1S) 3/32"V	11
205	5/8x6	T&G (V1S-S2S) 3/32"V	10	709	1x4 T&G (V1S-S2S) 1/4"V	12
206	5/8x8	T&G (V1S-S2S) 3/32"V	10	709R	1x4 T&G (V2S-S1S-Saw-textured 1S) 1/4"V	12
320R	1/2x4	Plain Saw-textured Bevel Siding (S1S2E)	17	711	1x6 T&G (V1S-S2S) 1/4"V	12
321R	1/2x5	Plain Saw-textured Bevel Siding (S1S2E)	17	711R	1x6 T&G (V2S-S1S-Saw-textured 1S) 1/4"V	12
322R	1/2x6	Plain Saw-textured Bevel Siding (S1S2E)	17	712	1x8 T&G (V1S-S2S) 1/4"V	12
323R	1/2x8	Plain Saw-textured Bevel Siding (S1S2E)	17	712R	1x8 T&G (V2S-S1S-Saw-textured 1S) 1/4"V	12
329R	3/4x6	Plain Saw-textured Bevel Siding (S1S2E)	17	713	1x10 T&G (V1S-S2S) 1/4"V	12
330R	3/4x8	Plain Saw-textured Bevel Siding (S1S2E)	17	713R	1x10 T&G (V2S-S1S-Saw-textured 1S) 1/4"V	12
331R	3/4x10	Plain Saw-textured Bevel Siding (S1S2E)	17	715	1x8 T&G (V1S-S2S) 3/32"V	11
360	1/2x4	Rabbeted Bevel Siding (S1S2E)	17	715R	1x8 T&G (V2S-S1S-Saw-textured 1S) 3/32"V	11
362	1/2x6	Rabbeted Bevel Siding (S1S2E)	17	716	1x10 T&G (V1S-S2S) 3/32"V	11
363	1/2x8	Rabbeted Bevel Siding (S1S2E)	17	716R	1x10 T&G (V2S-S1S-Saw-textured 1S) 3/32"V	11
371	3/4x6	Rabbeted Bevel Siding (S1S2E)	17	726R	1x6 T&G (V2S-S1S-Saw-textured 1S) 1/8"V	12
372	3/4x8	Rabbeted Bevel Siding (S1S2E)	17	727R	1x8 T&G (V2S-S1S-Saw-textured 1S) 1/8"V	12
373	3/4x10	Rabbeted Bevel Siding (S1S2E)	17	728R	1x10 T&G (V2S-S1S-Saw-textured 1S) 1/8"V	12
391	3/4x6	Rabbeted Saw-textured Bevel Siding (S1S2E)	18	732R	1x4 T&G (V2S-S1S-Saw-textured 1S) 1/4"V	12
392	3/4x8	Rabbeted Saw-textured Bevel Siding (S1S2E)	18	733R	1x6 T&G (V2S-S1S-Saw-textured 1S) 1/4"V	12
393	3/4x10	Rabbeted Saw-textured Bevel Siding (S1S2E)	18	734R	1x8 T&G (V2S-S1S-Saw-textured 1S) 1/4"V	12
400	1/2x4	Rabbeted Bevel Siding Round Edge (S1S2E)	18	761	1x6 Shiplap (S2S)	14
422	1 1/4x6	Plain Saw-textured Bevel Siding (S1S2E)	18	762	1x8 Shiplap (S2S)	14
423	1 1/4x8	Plain Saw-textured Bevel Siding (S1S2E)	18	763	1x10 Shiplap (S2S)	14
424	1 1/4x10	Plain Saw-textured Bevel Siding (S1S2E)	18	770	1x6 Cove Shiplap (S2S)	14
430	1x6	2 LAP (Round Edge) Drop Siding (S1S2E)	19	771	1x8 Cove Shiplap (S2S)	14
431	1x8	2 LAP (Round Edge) Drop Siding (S1S2E)	19	772	1x10 Cove Shiplap (S2S)	14
433	1x10	3 LAP (Round Edge) Drop Siding (S1S2E)	19	773	1x10 Channel Shiplap (S2S) Beveled Channel	14
476	1 1/4 x 6	Rabbeted Saw-textured Bevel Siding (S1S2E)	19	774	1x6 Channel Shiplap (S2S) Square Channel	14
477	1 1/4 x 8	Rabbeted Saw-textured Bevel Siding (S1S2E)	19	775	1x8 Channel Shiplap (S2S) Square Channel	14
606	1x6	T&G Drop Siding (S2S)	10	776	1x10 Channel Shiplap (S2S) Square Channel	14
616	1x6	T&G V&CV (S2S) 1/4"V	10	784R	1x6 Channel V&CV Shiplap (S1S-Saw-textured 1S) 1/4"V	15
617	1x8	T&G V&CV (S2S) 1/4"V	10	785R	1x8 Channel V&CV Shiplap (S1S-Saw-textured 1S) 1/4"V	15
632	1x4	T&G (S2S-CM)	11	786R	1x10 Channel V&CV Shiplap (S1S-Saw-textured 1S) 1/4"V	15
632EE	1x4	T&G EE (S2S-CM)	11	793	1x6 V Shiplap (S2S) 1/4"V	15
633	1x6	T&G (S2S-CM)	11	793R	1x6 V Shiplap (V2S-S1S-Saw-textured 1S) 1/4"V	15
633EE	1x6	T&G EE (S2S-CM)	11	794	1x8 V Shiplap (S2S) 1/4"V	15
634	1x8	T&G (S2S-CM)	11	794R	1x8 V Shiplap (V2S-S1S-Saw-textured 1S) 1/4"V	15
634EE	1x8	T&G EE (S2S-CM)	11	795	1x10 V Shiplap (S2S) 1/4"V	15
				795R	1x10 V Shiplap (V2S-S1S-Saw-textured 1S) 1/4"V	15
				810	1x6 Boston Shiplap (S2S)	15
				811	1x8 Boston Shiplap (S2S)	15
				812	1x10 Boston Shiplap (S2S)	15

INDEX

DECKING PATTERNS

PATTERN NUMBER		DESCRIPTION	PAGE	PATTERN NUMBER	DESCRIPTION	PAGE	
482	2x6	T&G Decking (S2S-CM)	21	487	2x8	T&G Decking (V1S-S2S) ¼"V	21
484	2x8	T&G Decking (S2S-CM)	21	488	2x10	T&G Decking (V1S-S2S) ¼"V	21
486	2x6	T&G Decking (V1S-S2S) ¼"V	21	489	2x12	T&G Decking (V1S-S2S) ¼"V	21

PLOWED FASCIA PATTERNS

PATTERN NUMBER		DESCRIPTION	PAGE	PATTERN NUMBER	DESCRIPTION	PAGE	
10				85	1x8	Single Plow EE	22
81	1x8	Single Plow EE	22	88	1x6	Double Plow EE	22
84	1x6	Single Plow EE	22	89	1x8	Double Plow EE	22

FENCING PATTERNS

PATTERN NUMBER		DESCRIPTION	PAGE	PATTERN NUMBER	DESCRIPTION	PAGE	
28	1x6	Fencing (S2S)	23	30	1x6	Fencing (S2S)	23
29	1x8	Fencing (S2S)	23	31	1x8	Fencing (S2S)	23

MOULDING PATTERNS

PATTERN NUMBER		DESCRIPTION	PAGE	PATTERN NUMBER	DESCRIPTION	PAGE	
75	1 ¹ / ₁₆ x1 ⁵ / ₈	Bed Mould	24	267	5 ⁵ / ₁₆ x1 ⁵ / ₁₆	Lattice	24
105	1 ¹ / ₁₆ x1 ¹ / ₁₆	Quarter Round Mould	24	268	5 ⁵ / ₁₆ x1 ¹ / ₁₆	Lattice	24
175	1 ¹ / ₄ x2	Brick Mould	24	558	5 ⁵ / ₁₆ x2 ¹ / ₂	Flat Batten	24
176	1 ¹ / ₁₆ x1 ⁵ / ₈	Brick Mould	24	559	1 ¹ / ₁₆ x1 ⁵ / ₈	O.G. Batten	24
180	1 ¹ / ₄ x2	Brick Mould	24	560	1 ¹ / ₁₆ x2 ¹ / ₄	O.G. Batten	24
208	1 ¹ / ₁₆ x2 ¹ / ₄	Panel Mould	24	712	9 ⁹ / ₁₆ x3 ¹ / ₂	Base Mould	24
210	1 ¹ / ₁₆ x1 ⁵ / ₈	Panel Mould	24	862	1 ¹ / ₁₆ x2 ¹ / ₂	Garage Door Stop	24
236EE	1 ¹ / ₂ x1 ¹ / ₂	Panel Mould	24	863	1 ¹ / ₁₆ x2 ¹ / ₄	Garage Door Stop	24
266	5 ⁵ / ₁₆ x1 ⁵ / ₈	Lattice	24				

1/32"

3/8" T&G Saw Textured

770

Core Shiplap

1/2"

Bevel pattern

Brick moulding #176

1" channel Shiplap S2S Beveled channel

1/2"

1/2"

ABB - 5/8" @ slope

1" furring S2S

note CF for Bevel siding as per CRA application

General

(1/2" x 1/2")

1/4"

1" to jaw 1/4" V Saw Textured